

Acoustical Design for Architects

Mike Wilson
Low Energy Architecture Research Unit
School of Architecture and Interior Design
University of North London
Spring House
6-40 Holloway Rd.
London N7 8JL
U.K.

Tel: +44 171 753 7006

Fax: +44 171 753 5780

Introduction

For good room acoustics the following conditions need to be satisfied

- 1) There needs to be good sound distribution in the room. This may be effected by various acoustic 'faults' such as concentrations and shadows, ringing and colouration, or echoes.
- 2) The background level needs to be an optimum for the acoustic activity in the space. Often this optimum will be the minimum sensibly obtainable but may not if masking noise is required such as in open plan offices.
- 3) The reverberation or rate of decay of the sound should be an optimum for the acoustic activity.

Sound Behaviour within Rooms

Sound within rooms can be analysed using different techniques. These can usefully be divided into the following categories:

1) Geometric methods. By using the basic law of angle of incidence equals angle of reflection the sound field may be described. The drawback of this method is that it takes no account of the wave nature of sound where typical wavelengths can be of the same order of magnitude as the reflecting or obstructing objects. One simple example of this is the acoustic barrier. The sound behind the barrier is not simply reduced equally over the whole noise spectrum but the tonal character is changed. The longer the wavelength or the lower the frequency the more the sound wave diffracts or bends round the barrier reducing the attenuation. With sound reflectors the lower frequencies may not 'see' the barrier at all, the middle frequencies may suffer diffuse reflection while only the higher frequencies undergo specular or mirror-like reflection.

2) Statistical methods. The rate of decay of sound in the room depends on the mean free path of the sound wave between reflections and the absorption of surfaces,

objects and air.

3) Wave Theory. A full description of the sound field in a room depends on solving the wave equations in that room. This is difficult without immense computing power and is normally limited to simple geometry. It is essential however in predicting standing waves (otherwise known as room modes or eigen functions) , and particularly important in small room (studio) acoustics.

Analysis of Room Shape

Most acousticians would try to avoid concave focusing shapes. If unavoidable they can be treated with absorber but this will often lead to loss of loudness. Concave shapes are often associated with echoes. Within approx 50 ms of the direct sound arriving at the listener the following reflections are integrated by the ear. Thus strong early reflections are very important in ensuring a sound is perceived sufficiently loudly. Where neither wall nor ceiling exist to provide these reflections the area of the floor in front of the source provides an important reflecting surface. This is important in amphitheatres where the apron provides such a facility. Rays can be drawn to ensure the audience can hear the reflected sound and this determines the raking. Note that glazing rays over the heads of an audience are heavily absorbed. A reflection arriving 80 ms after the direct sound will be perceived as part of the general reverberation of the room or if it is sufficiently strong as an echo. Concave shapes concentrate sound and therefore increase the likelihood of an echo. An important consideration is the relationship between the radius of curvature of the concave surface and the room dimensions. In the following diagram for a room with a dome or vault the radius should be less than half the source - max ceiling height to ensure the reflected sound is no more concentrated than that from a flat surface. Note that the sound reflected from a flat surface would be concentrated in distance d while the concave surface covers a distance d' .

Fig 1 (Source Ref 1)

A similar method can be applied to alert designers to the potential of an echo in an auditorium . Assuming a simple rectangular shape for an echo to occur two conditions need to be satisfied:

- 1) The path difference

between reflected and direct sound should be at least 17m. This is the distance covered by a sound

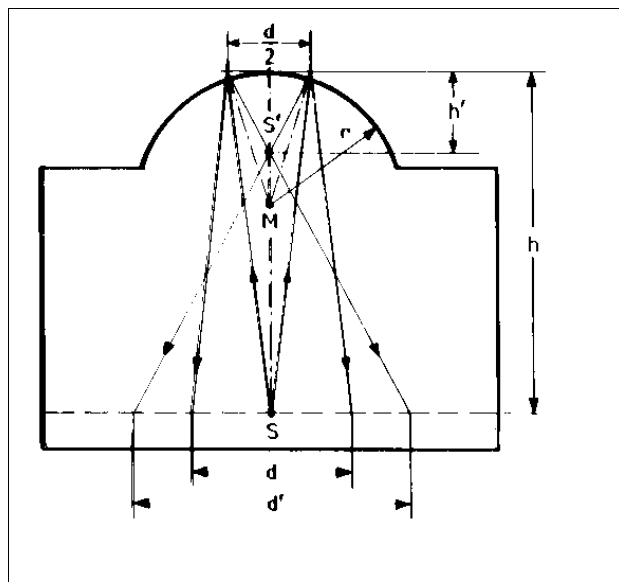

wave in 50 ms travelling at 340 m/s.

2) The reflected sound should have sound energy at least 10% of the direct sound.

The following diagram shows the critical dimensions

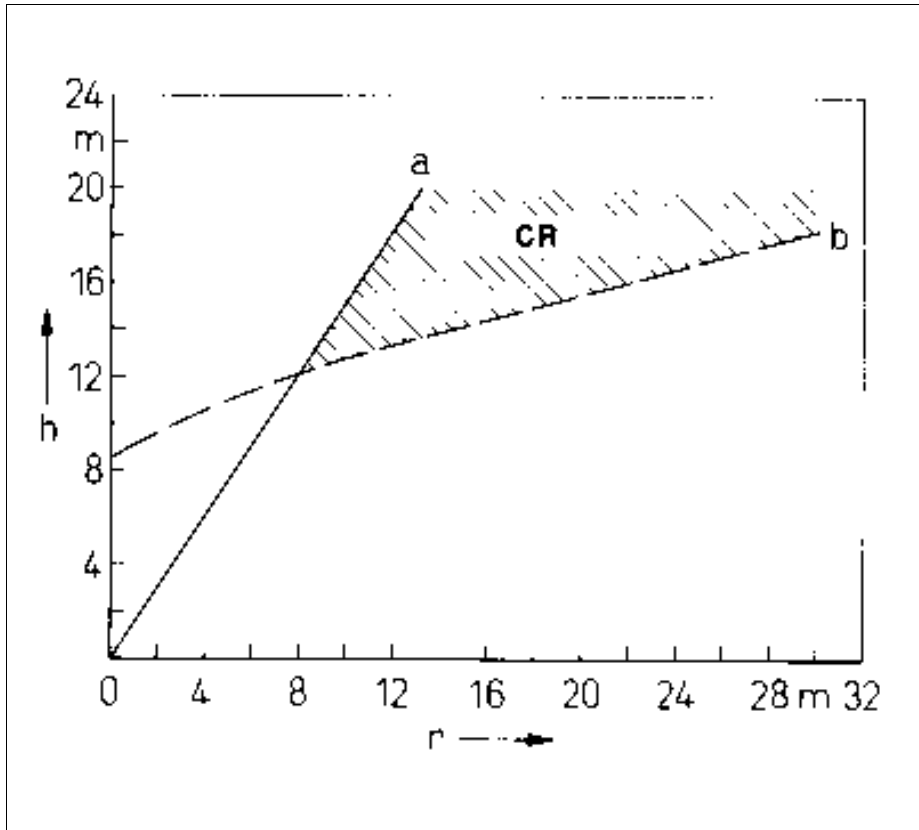
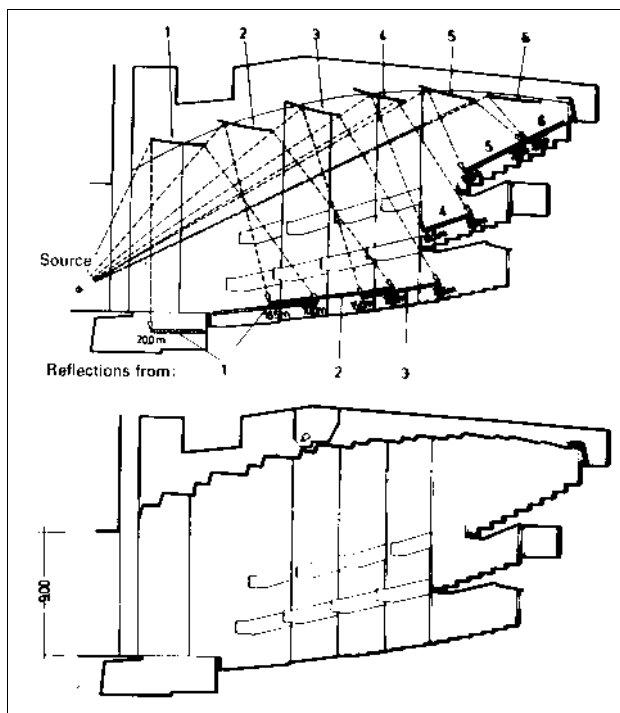

Fig 2 (Source Ref 1, p. 120.) CR = Critical Region, r , x - axis, source-receiver distance, h , y-axis, effective ceiling height

Ray tracing is a very common technique for investigating the behaviour of reflectors and an example is shown below

Fig 3 (Source ref 1, p 125) Ceiling profile for the German Opera in Berlin. Top: proposal based on ray construction. Bottom: ceiling as built (architect, Bornemann: acoustic consultants, Cremer and Gabler)



Elliptical shapes need very special consideration. It is vitally important that no source of sound is located

near either of the foci as these will be focussed at the other focus. They are best avoided but are a common architectural form.

In general the areas that need attention for echoes in theatres and concert halls are the rear wall, particularly the intersection of ceiling and rear wall and balcony fronts. This may be achieved by the use of absorber or correct orientation of the surfaces.

Reflectors are often used in theatres and concert halls either to increase early reflections to parts of the seating area which are some distance from the source or more particularly in concert halls to increase diffusion. Care must be paid to the size of the reflector as small reflectors will not reflect low frequency sound (due to diffraction effects) and the reflection does not become fully specular until the dimensions of the reflector are several times larger than the wavelength of the sound.

ringing and colouration are a phenomenon in small rooms that are caused by flutter echoes and standing waves. Some acousticians will argue that these are essentially the same phenomena but it is easier to treat them separately.

A flutter echo is caused by repeated echo between two hard parallel surfaces and is most clearly noticeable when the surfaces in the other dimensions are absorbing. Where the dimension of the space is small these appear as a ring but with larger dimensions can appear like (subdued) rapid machine gun fire. They can be cured by treating one of the surfaces with absorber or where this could cause an unacceptable loss in reverberation such as in a recording studio by building the walls out of parallel- an early acoustic version of deconstructivism.

Sound as a wave

To understand standing waves it is necessary to understand a little about sound as a wave.

Sound in air is a longitudinal wave, that is the pressure fluctuations which are the sound wave take place in the direction of travel of the wave. A pure tone is a sine wave where the wavelength is the distance between two successive compressions or rarefactions and the frequency is the number of waves that pass a point in space every second.

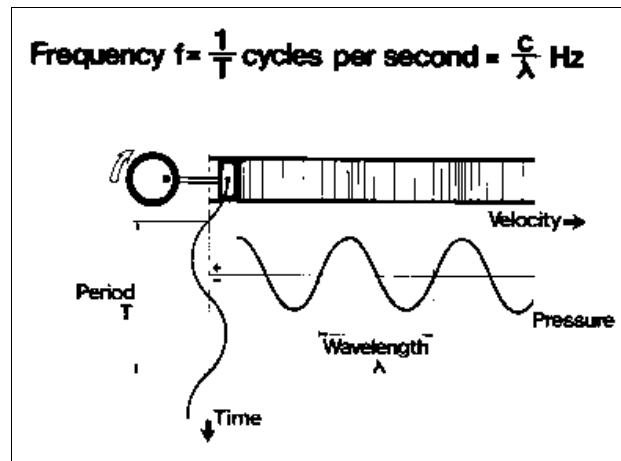

Fig 4

The range of audible sound stretches from a frequency of 20 Hz to 20000 Hz (Hz = Hertz = waves per second). As we grow older our hearing at the high frequencies falls off (presbycusis) . Additionally hearing loss caused by excessive noise during a lifetime (the permanent threshold shift as opposed to the temporary threshold shift which is experienced when coming out of a noisy space such as a disco) occurs at high frequencies around 4 kHz.

Standing waves are caused by the incident and reflected wave at a surface interfering with each other. The result is a series of nodes and antinodes in space, the former being places where there is no change in the relevant property (e.g. sound pressure) with time and the latter where the property fluctuates at a maximum. A pressure fluctuation maximum (antinode) is produced against the wall whereas the air particles can barely move against the hard wall and give rise to a particle velocity node. A partial standing wave is formed against any surface but a full standing wave will not be set up unless the nodes and antinodes from another partial standing wave formed against an opposite parallel surface coincide. The room dimension under which this will occur is related to the wavelength by the expression:

$$l = n\lambda/2 \text{ where}$$

l = room dimension

λ = wavelength

and n is an integer

These are known as the axial room modes but they can occur in two or three dimensions known as correspondingly as the tangential and oblique modes.

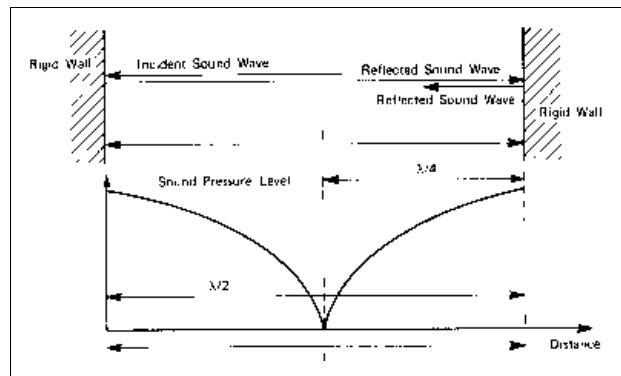

Fig 5 (Source ref 2) Axial Modes

The room modes (frequencies) for a simple (undamped) rectangular room are given by the expression:

$$f = c/2\{(n_x/l_x)^2 + (n_y/l_y)^2 + (n_z/l_z)^2\}^{1/2}$$

where f is the frequency

c is the velocity of sound in air (340 m/s at room temp.)

$n_{x,y,z}$ are integers

and $l_{x,y,z}$ are the room dimensions

If a room is cubic the room modes are widely spaced at the lower frequencies and can lead to very poor acoustics. With small room dimensions the shortest wavelength to give rise to a standing wave is within the audible range e.g for a room dimension of 3.4m a room mode (an axial mode) is formed at 50 Hz and if the room is cubic the next mode (a tangential mode) would be at 71 Hz. For larger room dimensions the fundamental standing waves where the large spacing will occur are below the audible range and so there is less of a problem. In order to avoid as far as possible these low frequency standing wave problems room dimensions are chosen for acoustically critical spaces to produce as many evenly spaced modes as possible. One commonly used room ratio is the 'golden ratio' $n_x : 2^{1/3}n_y : 2^{2/3}n_z$

where $n_{x,y,z}$ are integers

If all integers = 1 then this produces a ratio 1 : 1.26 : 1.6. Another suggestion from the BBC in London is in relation to room height 1.14 +/- 0.1 : 1.4 +/- 0.14 (ref 3).

The increase in the number of modes with frequency can be shown from analysis of a large hall with dimensions 50m x 24m x 14m with a volume of 16 800 m³ which between 0 to 10 000 Hz has about 1.8×10^9 modes and at 1000 Hz the number of modes is about 5400 per Hz(ref 4).

The decay of sound in rooms

At each reflection of a sound wave from a surface, unless that surface is infinitely hard, a reduction in amplitude of the incident sound will occur. If the sound source in a room is switched off this causes the sound field in the room to decay. This decay is commonly called the reverberation of the room.

The sound pressure level in a room is measured in decibels which is a logarithmic scale.

It is defined by the expression $L_p = 10 \log_{10} (P/P_0)^2$ or $20 \log (P/P_0)$

where L_p is the sound pressure level in dB and

P is the sound pressure (Pascals or N/m^2) and

P_0 is the sound pressure at the threshold of hearing at 1000 Hz. which is taken as 2×10^{-5} Pascals.

Alternatively the intensity level in a room (a measure of energy rather than pressure) is given by the expression

$$L_i = 10 \log (I/I_0)$$

where L_i is the intensity level in dB

and I is the sound intensity in W/m^2

and I_0 is the reference sound intensity which is chosen as $10^{-12} W/m^2$ so that $L_p = L_i$ in a free field (that is without any reflecting surfaces)

Noises sound differently according to the frequency content of the noise and measurements are often made in frequency bands. In building acoustics these are generally in octave or 1/3rd octave bands. These bands follow a geometric progression. An octave band is the group of frequencies between one frequency and twice that frequency e.g. 500 - 1000 Hz. The standard octave bands now used are described by their centre frequencies which are the bottom frequency in the band x 1.414. 1/3rd octaves are octave bands divided into three parts following the same geometric progression.

The standard octave bands are (audible range) 31.5, 63, 125, 250, 500, 1000, 2000, 4000, 8000, 16000 Hz. Examples of the 1/3rd octave bands are 100, 125, 160, 200, 250, 315, 400, 500, 630, 800, 1000 etc. As a comparison with musical notes middle C on a piano keyboard is 256 Hz.

The reverberation in a room is characterised by the reverberation time (RT) defined as the time it takes for the sound level to decay by 60 dB or for the sound energy in the space to decay to one millionth of its original value. It is measured using either an impulsive source such as a starting pistol or by switching off a white or pink noise source and measuring the decay. This decay is usually measured over 20 dB or 30 dB from -5 to -25 dB or -5 to -35 dB but always expressed as an equivalent 60 dB decay. The early decay time (EDT) measured from 0 to -10 dB, though again expressed as the equivalent 60 dB decay, is more closely related to the subjective

impression of decay. This is calculated using the 'Schroder reverse integration' technique. In all cases the RT or EDT should be measured in octave bands or 1/3 octave bands as the absorbing properties of the surfaces will vary with frequency.

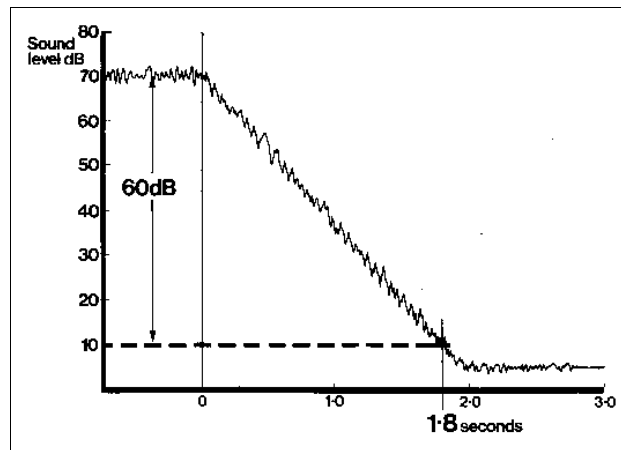

Fig 6
Measurement of Reverberation Time

Rooms for Speech

The structure of speech consists of combinations of vowels and consonants to produce voice tones sometimes called 'formants' which can be varied over a small frequency range (pitch) by the person but are generally characteristic of the way that person speaks. Females have generally a higher pitch region than males in which their formants occur.

Speech is understood mainly by the overtones or harmonics on the consonants. The important frequency range for understanding speech is between 500 - 4000 Hz.

The listener hears a direct sound from the speaker and then the reflected sounds. To reiterate earlier statements, those reflected sounds arriving within 50 ms of the direct sound are not distinguishable by the ear. Effectively the ear has a certain integrating time. These early reflections contribute to the level of the direct sound while those arriving after 50ms contribute to the general reverberation of the space. While the level of the direct sound can be increased by standing closer to the speaker the general reverberation in the space remains constant. Thus where the direct sound and early reflected sound is already at a reasonable level for listening the clarity of the the speech cannot simply be increased by the speaker talking louder, unless the externally created background level is high. A good example of this is the public address system in swimming pools (or underground train stations) where simply increasing the amplification has no effect on speech articulation

In acoustics the Clarity (for speech) is defined as:

$C = 10 \log E/L$ where E is the sound energy arriving within the first 50 ms and L the sound energy arriving after the first 50 ms.

Good early reflections and good sight lines to the audience are very important in

rooms for speech. Good sight lines are important acoustically as they prevent absorption of the direct sound by grazing incidence over the heads of the audience. Much of the absorption of the sound in a room for speech (this reduces the reverberation) comes from the audience and seats and, for optimum reverberation times between 0.7s and 1.2s the room volume should be about 3m³/person. Because of the directional nature of the human voice the seats should lie within 140° angle width of the speaker.

Rooms for Music

Musicians employ many terms to describe the musical acoustic qualities of a hall e.g. warmth, said to be improved by a longer reverberation time at low frequencies. Music to be played in small halls, chamber music for a small number of musicians, is composed knowing there will be limited reverberation. Concert halls for large symphonies need much longer reverberation times to ensure the musical notes blend. Opera houses lie somewhere between. Typical reverberation times in large concert halls should be around 2s while those for opera houses in the range 1.4s - 1.7s. In these larger halls the reverberation time may be allowed to rise up to 50% at the low frequencies.

Early energy in music rooms is defined as the sound arriving within the first 80ms. The lateral energy fraction(LEF) is defined as the ratio of the sound energy picked up in the first 80 ms by a figure of eight microphone (aligned along axis through ears) compared to the total energy. There have been several subjective and (objective) surveys of concert halls. Barron (ref 5) used the attributes clarity, reverberance, envelopment, intimacy, loudness and balance developed as mutually independent criteria from earlier studies by Hawkes and Douglas(ref 6)) and Cremer and Muller (trans Shultz) (ref 1). Correlations of reverberance with the mean EDT over the bass and mid frequencies , envelopment with the lateral energy fraction (improved if bass total sound level and mid-frequency EDT is added), and intimacy with the early sound level (the sound level arising from the early energy).

Fan shaped halls provide little lateral energy and therefore poor envelopment. The traditional shoe box halls are known for having good acoustics and the lateral energy is high. It is cost restraints that have led to the abandonment of the shoe box but faceted reverse fan shapes such as the Royal Centre, Nottingham,UK (ref 7) and shoe box derivatives such as the new Birmingham Symphony Hall, Birmingham, UK (ref 8) have attempted to address this problem.

Calculation of Reverberation Time

Sabine's formula is generally used for the calculation of reverberation time unless the space is quite absorbing

R.T. = $0.16 \times V/A$ where V is the volume of the room in m³ and A the absorption area in m² or Sabines.

To calculate the absorption area, the absorption of the surfaces, any people or furniture, and air need to be taken into account although the latter, which is a function

of the humidity of the air, can be ignored except at high frequencies in large spaces.

The absorption coefficient of a material (α) is defined as the fraction of incident energy not reflected. Whether this sound is absorbed or transmitted at the surface is unimportant for the room internal acoustics. The absorption area of a surface 1 given by:

$$A_1 = \alpha_1 S_1$$

where α_1 is the absorption coefficient of surface 1 with surface area S_1

For a room with n surfaces total surface absorption area $= \sum \alpha_n S_n$

A person contributes about 0.4m^2 of absorption area @ 1000 Hz, and the absorption area per cubic metre of air is approx 0.003 m^2 @ 1000 Hz

Sabine's formula is derived assuming continual decay of sound. If we work out the mean free path in a space and assume that the sound decays when it strikes a surface a more accurate formula, Eyring's formula results. This gives a significantly different result if the sound absorption coefficient exceeds 0.2.

$$R.T = -0.16V/S \ln(1-\alpha_m)$$

where α_m is the mean absorption coefficient of the surfaces

These formulae only apply when the room dimensions are similar. They do not predict the behaviour in long low factories or long corridors. Calculation of theoretical reverberation time is never exact.

Sound Absorbing materials

These can be divided into three types:

- 1) Porous Absorbers
- 2) Panel or membrane absorbers
- 3) Helmholtz resonators

- 1) Porous Absorbers

These can be foamed open cell plastics, mineral fibre or similar usually compressed with a little glue, or sintered materials eg stone leaving an open pore structure. Absorption is essentially by friction of the sound wave within the open pores.

To understand a little more about absorption (and later transmission) it is worth introducing the concept of acoustic impedance. This is analogous to electrical impedance where you have an ac rather than dc supply (voltage divided by current). For plane waves it is simply the ratio of the sound pressure and the associated particle velocity and is equal to the density of the medium multiplied by the velocity of sound in that medium.

$$Z = \rho \times c$$

where z is the acoustic impedance (for air =415 rayls) and ρ is the density of the medium. For other types of waves eg standing waves the relationship is more complicated and is best described mathematically in terms of complex numbers.

For absorption the wave must be able to get into the material. The pores must be big enough to let in the wave but not too large to reduce friction. The former is a way of saying that air and the material must have similar acoustic impedances. A large impedance mismatch ensures that the sound wave is mainly reflected. In practice an absorber with an acoustic impedance of two or three times that of air is used which for mineral fibre is obtained with a density between 40 - 100 kg/m³.

Previously it was described how a partial standing wave is formed against a wall. For a hard surface and a sound wave incident normally to the surface , there is a particle velocity node against the wall and an antinode at a distance of one quarter wavelength from the wall. This means that there is zero movement of air at the wall surface (no friction, no absorption) and maximum movement of the air at a quarter of a wavelength from the wall (maximum friction, good absorption). Therefore the absorber should be at least as thick as a quarter of a wavelength to get the best absorption and relatively thin layers would have very poor absorption. Of course we have only considered normally incident waves and ignored other effects but the principle applies. Thin materials only become good absorbers when placed away from walls. That is why acoustic tiles in suspended ceilings are much better absorbers than when stuck directly on the ceiling.

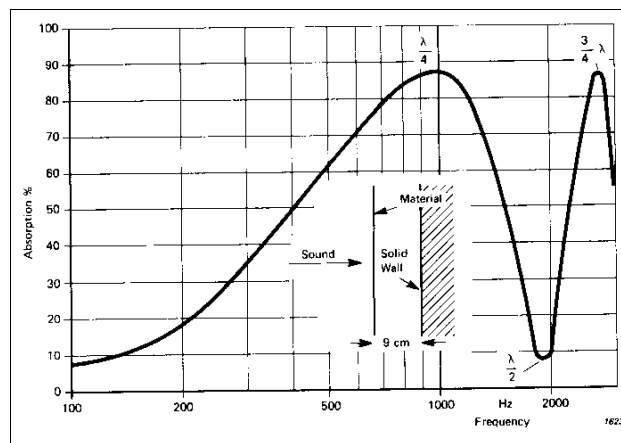

Fig 7 Absorption characteristics of an absorptive material mounted 90 mm from a solid wall (Source ref 2)

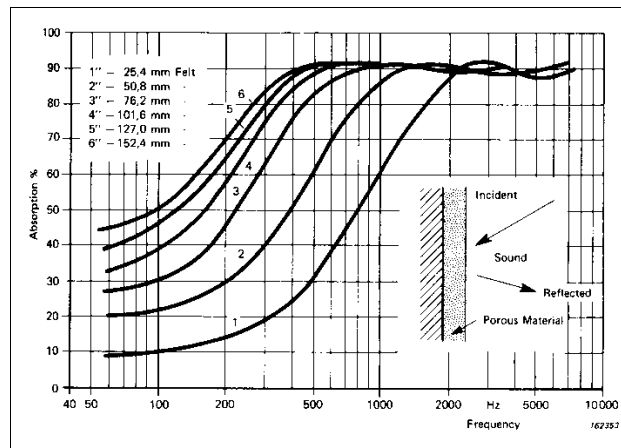

Fig 8 Dependence of the absorption of a porous material on the thickness of the material (Source ref 2))

Panel or membrane Absorbers

A wood panel with an air space between it and the wall will act as a resonance system absorbing sound. The air space is the spring and the wood panel the mass attached to it so it resembles a weight hanging on the end of a spring and has a natural frequency of oscillation. Sound is absorbed at this natural frequency setting the system into resonance. The narrower the air gap the stiffer the spring and the higher the natural frequency of the system. The resonant frequency is given by the expression: $f = 60/(md)^{1/2}$ where

m is the superficial mass or surface density of the panel in kg/m^2 and d is the air gap in m .

This is a reduction of the expression for a double panel resonating system :

$$f = 60 \{(m_1 + m_2)/m_1 m_2 d\}^{1/2}$$

where m_1 and m_2 are the masses of the panel. This frequency is important in the sound insulation of multiple partitions and is known as the mass-air-mass resonant frequency.

For a typical plywood panel (10 mm) with a 50mm air gap this resonant frequency works out about 100 Hz. Practical panel absorbers absorb around the resonant frequency, with in the absence of friction, theoretical perfect absorption at the resonant frequency. However stiff panels reradiate sound limiting the absorption coefficient to about 0.3 at the resonant frequency. This can be slightly improved by placing sound absorber in the air space to damp the air vibrations but it is more effective to damp the panel by addition of heavily internally damped materials such as bitumen roofing felt. Note that for damping to be successful the damping material must be heavy compared to the material being damped. Successful damped materials for machinery casings have been made however using a thin visco-elastic layer between two alloy sheets. These are known as sandwich materials.

While the absorption of porous materials is biased towards the high frequencies, unless a very thin membrane such as a stretched skin is used, panel absorbers offer useful complimentary low frequency absorption.

Helmholtz Resonators

Helmholz resonators are like bottles with a cavity and a neck. The sound wave causes the plug of air in the neck to vibrate, the air in the cavity undergoing periodic compression and rarefaction. The friction new to the increased motion of the air particles in the neck and the neck itself causes absorption the sound absorption is highly tuned to the resonant frequency given by:

$$f = c/2\pi\{S/lV\}^{1/2} \text{ where}$$

c = velocity of sound(m/s)

S = cross sectional area or neck (m^2)

l = length of neck (m)

V = volume of cavity (m^3)

There is limited use for an absorber with such fine tuning (taking out particular tonal sounds in ducts and artificial reverberation systems) but if the resonator is filled with absorber the absorption at resonance is reduced (and there is a slight change to resonant frequency) but the absorption is spread over a much larger range.

Some acoustic panels are hybrids between Helmholtz absorbers and porous absorbers, placing a perforated sheet over a layer of porous materials. If the perforations exceed 25% the covering panel can be ignored but with a lower percentage perforation a resonance frequency will occur, the net result normally being to increase the low /mid frequency absorption and reduce the high frequency absorption.

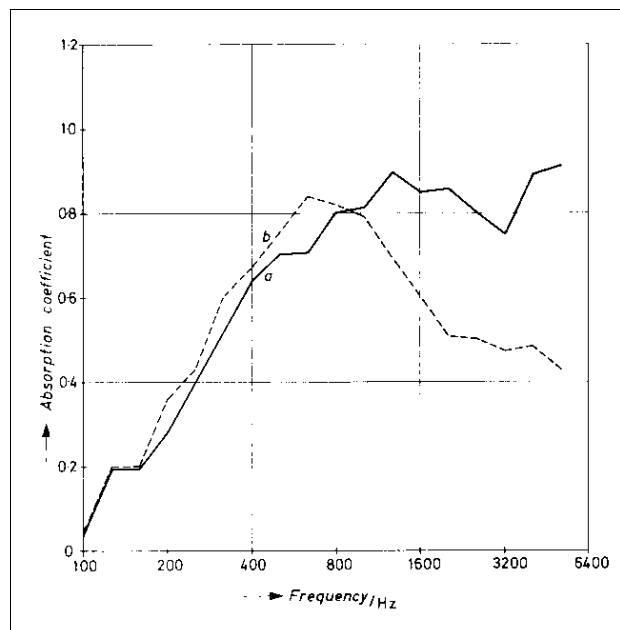

Fig 9 (Source ref 4) Absorption Coefficient of 50 mm glass wool, mounted immediately on concrete a) uncovered, b) covered by a panel of 5mm thickness, perforated at 14%.

Room Sound Level

According to traditional theory, which assumes that the ratios of the room dimensions are not too dissimilar, the total sound level within a room is due to the direct sound from the source which depends on distance and the reverberant sound which is constant throughout the room.

To determine the room sound level we need to know how much sound power is being put into the room. Sound power is measured in Watts and the corresponding sound power level is given by the expression:

$$L_w = 10 \log(W/W_0)$$

where L_w is the sound power level (dB)

and W is the sound power (Watts)

and W_0 is a reference sound power taken as 10^{-12} Watts

Direct Field

If we assume that a source of sound power, W , radiates omnidirectionally then :

$$I = W/4\pi r^2$$

where r is the distance from the source. Introducing the term directivity factor, Q , (p^2_θ/p^2_{mean}), where θ is the angle at which we are measuring the directivity then:

$$I = QW/4\pi r^2$$

For example, an air supply grille in a wall would have approx $Q = 2$ for all angles.

In a free field (no reflecting surfaces)

$$L_p = L_i = 10 \log(QW/4\pi r^2)$$

Reverberant field

The reverberant field will be created by that part of the sound power left after the first reflection:

i.e. $W_{R1} = W(1 - \alpha)$ after the first reflection, where α is the mean absorption coefficient and W_{R1} is the sound power entering the reverberant field.

If we then include the sound power left after all the subsequent reflections

$$W_R = W (1 - \alpha)/\alpha \text{ where } W_R \text{ is the total sound power in the reverberant field}$$

The reverberant sound intensity (I_R) is then:

$I_R = W(1 - \alpha)/S\alpha$ where S is the total surface area of the room and

$I_R = W/R$ where R is the room constant = $S\alpha/(1 - \alpha)$

It can be shown that the intensity in a reverberant field for a given sound pressure is a quarter of the intensity measured in a free field (pressure is a scalar quantity, intensity is a vector) which leads to the expression:

$$L_p = L_w + 10 \log(Q/4\pi r^2 + 4/R)$$

If the reverberant field is dominant we can make an approximation that all the energy goes directly into the reverberant field. Then $W_R = W/\alpha$ and:

$$L_p = L_w + 10 \log(4/A) \text{ where } A \text{ (the absorption area) } = S\alpha$$

The reduction in sound level by introduction of further absorption area in dB
= $10 \log(A'/A)$ where A' is the new absorption area.

Note that substantial reductions in room sound level can be obtained if the amount of absorption is initially small and is a useful means of reducing overall noise levels in noisy reverberant factory spaces.

The formulae above apply to spaces with similar dimensions. Spaces which are long and low (e.g. some factory units) do not allow uniform reverberant fields to develop. There is a continual reduction in noise level as the distance from the source increases, and the flexing of a typical low bay factory roofs can cause absorption of the sound at mid frequencies and increased attenuation. Absorbers hanging from or applied to the roof can also increase the sound attenuation with distance from the source. For example in a factory space 75m x 39m x 8m high made of sheet steel the reduction in sound level may be 3.5dBA per doubling of distance without absorber and 5.6 dBA with 80% roof coverage of 50mm mineral wool slab with an overall sound reduction of about 7-8 dBA.

Outdoor Noise Propagation and Environmental Noise.

In the preceding section it was indicated that the sound pressure level in a free field was inversely proportional to the square of the distance from a sound source - the inverse square law. Expressed logarithmically as decibels this means the sound level decreases 6 dB with doubling of distance. This applies to a point source of sound. If the source is uniform and linear then the decrease is only 3 dB per doubling of distance. For a large area source there is no decrease with distance.

Rathe (ref 9) has shown that for a building of elevation dimensions a and b the building will behave as an area source until the distance d from the building $> a/\pi$ or b/π and then as a linear source until a/π and $b/\pi < d$ after which a point source can be assumed.

Air absorption is important over large distances at high frequencies, depends on

humidity but is typically about 40 dB/km @ 4000Hz. Note that traffic noise frequencies are mainly mid/low and will be unaffected below 200m.

Wind

Sound propagation is affected by wind gradient rather than the wind itself. Ground causes such a gradient. Sound propagating upwind is refracted upwards creating a sound shadow and downwind refracted towards the ground producing a slight increase in sound level over calm isothermal conditions.

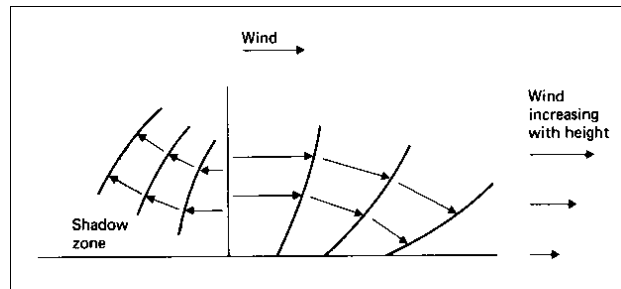

Fig 10 (Source ref 10) The effect of wind on wavefront

Temperature Gradient

The velocity of sound is inversely proportional to the temperature so a temperature gradient produces a velocity gradient and refraction of the sound. Under most conditions temperature decreases with height and the sound is refracted upwards.

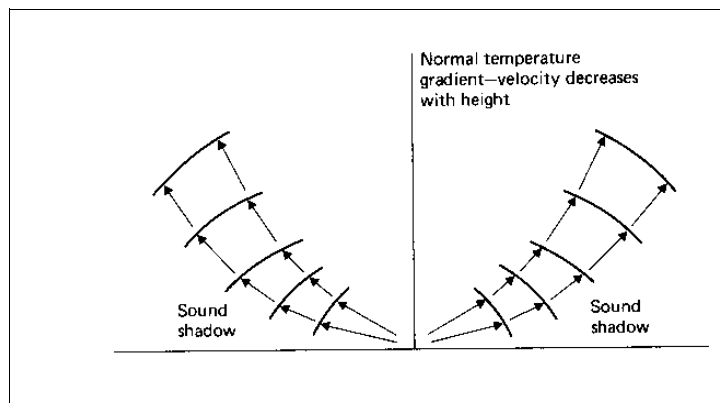

Fig 11 (Source ref 10) Normal Temperature Gradient effect

Under temperature inversion conditions the sound is refracted downwards and can cause noise to travel over large distance. It can be particularly noticeable when an aeroplane moves through the temperature inversion layer. Sometimes focussing can

occur and a noise can be heard louder at a distance than at closer points.

Ground Absorption

For source and receiver close to the ground quite large attenuation can be obtained at certain frequencies over absorbing surfaces, noticeably grassland. This attenuation is caused by a change in phase when the reflected wave strikes the absorbing ground and the destructive interference of that wave with the direct wave. The reduction in sound tends to be concentrated between 250 Hz and 600 Hz.

Noise screening

Trees are often suggested as noise screens but they need to be tens of metres wide to provide reasonable attenuation. In addition they need to be evergreen to provide all year round performance. This does not negate the fact that trees can act as good sound reflectors back to the source, often causing echos.

Earth mounds, walls and cuttings can provide good attenuation. Because the wavelengths of sound are quite large at low frequencies, through diffraction effects the sound can bend over barriers. The performance of barriers is therefore frequency dependent. Barriers with two edges tend to perform better than those with a sharp edge eg. Walls. To avoid sound transmission through the barrier itself the superficial mass should be greater than 10 kg/m².

Fig 12
Barrier
Attenuation

For values of $2(A + B - d) / \lambda$ between 1 and 10 then attenuation is given approximately by:

$10 \log[2(A + B - d)/\lambda] + 13$ giving values between 13 and 23 dB.

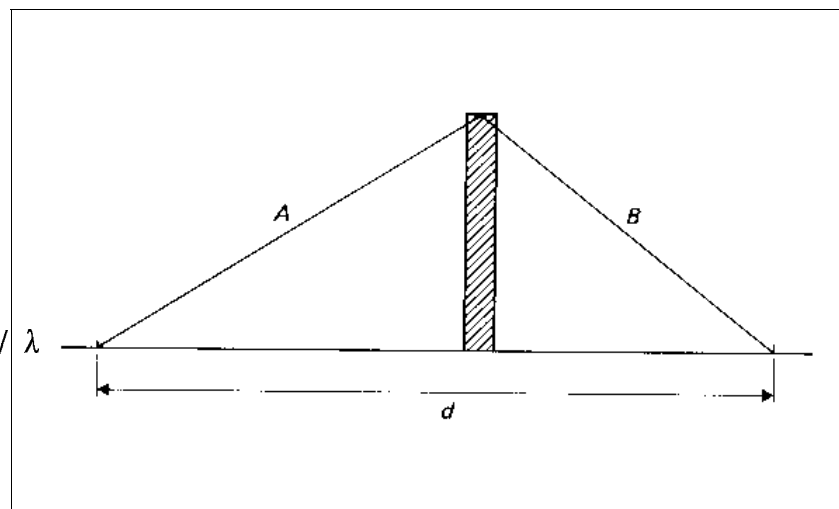

Environmental Noise.

There is a complex relation between subjective loudness and the sound pressure level and again between annoyance due to noise and sound pressure level. In general the ear is less sensitive at low frequencies.

Fig 13 (Source ref 2) Equal loudness contours

Weighting scales have been included on sound level metres to give a measurement more closely related to subjective response to noise. The 'A' scale is the most weighted and was initially used for low level sounds. However it has been found to correspond most closely to subjective noisiness and is most commonly used in environmental noise measurements.

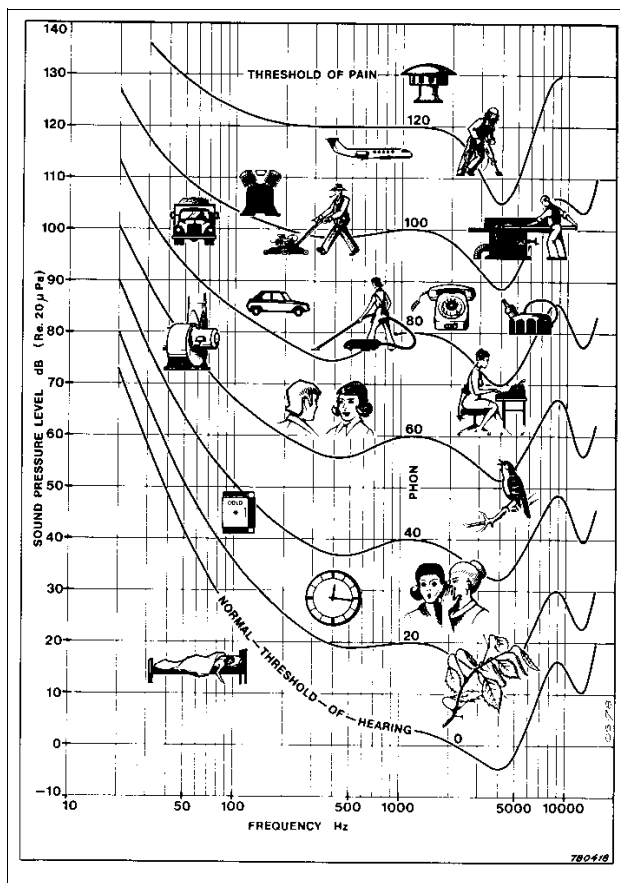

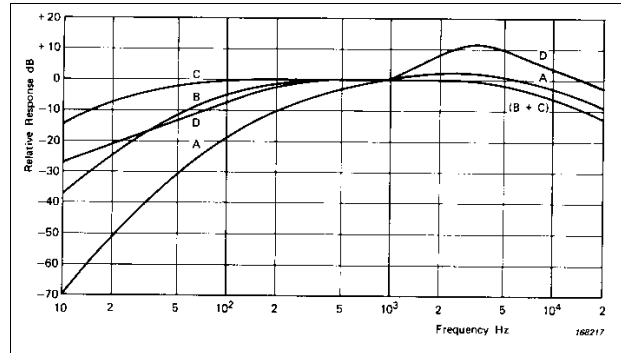

Fig 14 Weighting scales

Many sounds vary in level and there are several indexes used for measuring these varying sounds. Most commonly the equivalent continuous sound pressure level is used, L_{eq} . If measured on the 'A' scale it is known as L_{Aeq} .

It is based on the principle of the average energy in the sound over the measurement period in question. Sometimes the measurement period is included as well, $L_{aeq,T}$, where T is the measurement period.

The sound exposure level, SEL or LAE or LAX, is the level which, if maintained for one second, would deliver the same A-weighted sound energy as a given noise event. An example of its use would be in measurement of rail noise. Rail noise is often measured as the L_{Aeq} over a 24 hour period. Let us assume the same type of train passed at certain intervals over a given day, making similar amounts of noise. By measuring the SEL of one train, performed by direct measurement or by $SEL = L_{Aeq,T} + 10 \log T$, the $L_{Aeq,24h}$ could be calculated with a knowledge of the number of trains in the 24 hour period,

$$L_{Aeq,24h} = SEL + 10 \log N - 10 \log (60 \times 60 \times 24)$$

where N is the number of trains.

In the U.K. the $L_{Aeq,16h}$ is now generally used for aircraft noise, assuming no flights or severe restrictions at night.

While the L_{Aeq} is increasingly used for measurements of all types of noise, early research in the U.K. showed that of simple statistical noise measurements the L_{A10} was the best correlated with annoyance from traffic noise. The L_{A10} is the A-weighted sound pressure level exceeded for 10% of the time. Background noise level is often described by the L_{A90} .

European Health and Safety regulations restrict noise exposure by use of an 8 hour L_{Aeq} , requiring action to be taken if $L_{Aeq,8h}$ exceeds 85 dB and further action if it exceeds 90 dB.

While L_{A90} is often used for environmental background noise level, for internal spaces L_{Aeq} or Noise Rating/Criteria curves are used. The British Standard Code of Practice

for Sound Insulation and Noise Reduction in Buildings (BS 8233:1987) uses L_{Aeq} to describe maximum/optimum background levels in internal spaces. For instance for cellular offices $L_{Aeq} = 40 - 45$ dB is recommended while for open plan offices $L_{Aeq} = 45 - 50$ dB is recommended. Note that these are optimum levels. With the limited sound insulation from office partitions a reduction in the background noise level in cellular offices can lead to a loss of acoustic privacy and with the open plan offices the background noise level (or masking noise) actually provides the acoustic privacy. Consideration must also be given to the background noise itself. Road traffic noise is variable and the frequency spectrum itself is not ideal for masking speech. Mechanical service noise is better but certain air conditioning systems such as VAV have variable noise levels, being much quieter under low load conditions. In some circumstances with open plan offices an electronically created noise (often white noise) is introduced into the office to provide masking.

Noise Rating and Noise Criteria curves (and their derivatives) were developed mainly to specify building services noise, the former being a European development and the latter a development from the USA. Although they can be used in conjunction with L_{eq} 's or L_{10} 's to specify varying noises they are basically devised for steady sounds and the curves generated from octave band noise levels. To satisfy a particular Noise Rating/Criteria the level in any of the octave bands should not exceed that specified by the particular curve. An approximate relation is $L_{Aeq} = NR + 8$ but will vary according to noise spectrum of source.

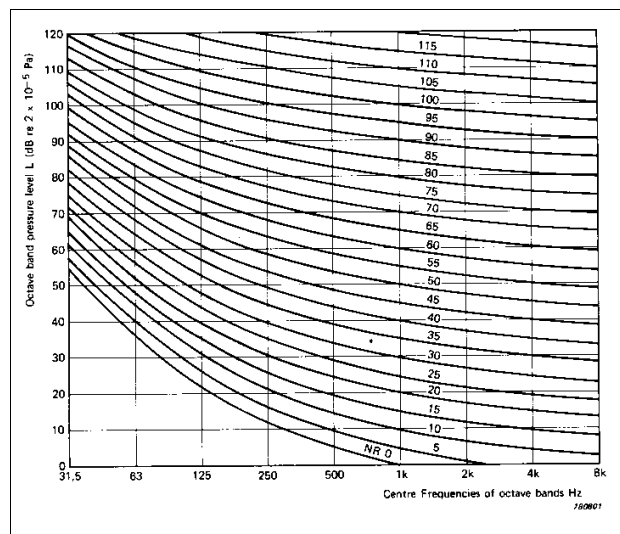

Fig 15 Noise rating curves

In the example of the offices above, the sound as heard by a cellular office occupant (their acoustic privacy) can be described by the the sum of the mean sound insulation { expressed as the SRI(sound reduction index-see section on sound insulation)} and the ambient noise level in dBA (= L_{Aeq} if noise steady) or NR(ref 11)

Sound as heard by Occupant

Mean SRI + L_{Aeq}

Mean SRI + NR

Intelligible	70	65
Ranging between intelligible and unintelligible	75-80	65-75
Audible but not intrusive (unintelligible)	80-90	75-85
Inaudible	90	85

Sound Insulation

The sound insulation of a single panel of material will depend on the frequency of the sound and its mass. Its insulation in practice will also depend on its fixing and very much on the quality of the workmanship.

The force on a panel due to a sound wave in air could be described by Newton's Second Law of Motion. That is force = mass x acceleration. In simplified terms the acceleration produced and consequently the acceleration given to the air molecules on the other side of the panel and the resulting sound pressure in the transmitted wave will depend on the mass of the panel. This will apply except where the panel is thin and/or flexible. In this latter case the panel will vibrate as a whole and the transmission governed by its stiffness.

A more detailed treatment is based on the principle of continuity of the pressure and particle velocity at each boundary. That is the sum of the incident and reflected pressures must be equal to the transmitted pressure and the same applies to the particle velocity. Assuming no loss of energy at each boundary, and remembering that the impedance of a material is given by the ratio of the pressure to the particle velocity, at a single boundary:

$$\alpha_t = 4z_1z_2/(z_1 + z_2)^2 \text{ If } z_2 \gg z_1 \text{ then } \alpha_t = 4z_1/z_2$$

where α_t is the sound (power)transmission coefficient, z_1 is the impedance of air (415 rayls), and z_2 is the impedance of the material. Examples of impedance: concrete = 8.1×10^6 rayls, sea water = 1.54×10^6 rayls.

For a finite panel with air either side solving, the continuity equations at each boundary the sound transmission coefficient (T or α_T) is given by:

$$T = 1.75 \times 10^4/m^2f^2$$

Where m is the surface mass of the panel in kg/m² and f is the frequency in Hz.

This formula is derived on the basis of normally incident plane waves and that the partition is rigid so that no other vibrations are set up. It is commonly known as the mass law. The sound transmission coefficient is more conveniently expressed in a logarithmic form as the sound reduction index:

$$SRI = 10 \log (1/T)$$

This leads to the expression $SRI = -42.4 + 20 \log mf$

This implies that there is a 6dB increase in sound insulation if either the mass or the frequency is doubled. For randomly incident sound the practical increase is nearer 4.5 or 5 dB per octave and a typical mass law expression could be:

$$SRI = -17 + 15 \log mf$$

In the proceeding section we have ignored the stiffness of the panel but this becomes dominant at low frequencies. Resonances which occur at the natural vibrating frequencies of the partitions depending on the partition dimensions and fixings, and bending waves set up at higher frequencies both reduce the partition insulation below that expected from the mass law.

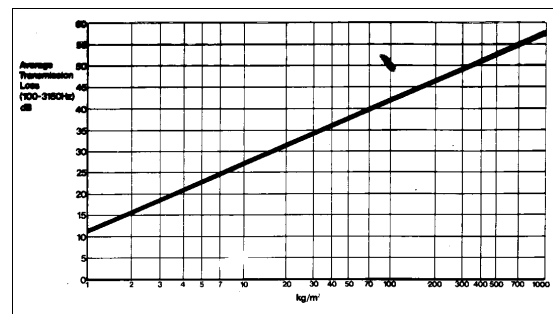
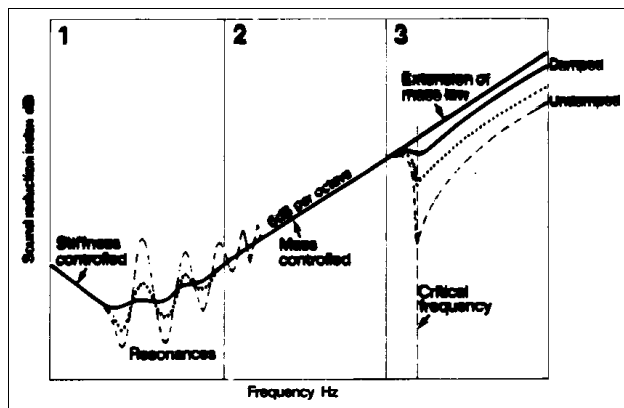

Figs 16 and 17 Sound Transmission of a single partition

The Coincidence Effect

Solids can transmit shear forces so that in addition to longitudinal compression waves, shear waves and bending waves can be transmitted. The phenomenon of bending waves that are set up in a partition is known as the Coincidence Effect. At grazing incidence where the wavelength of the sound in air is the same as the bending wavelength of the partition the transmission of the sound is high with consequent loss of insulation. This frequency is known as the Critical Frequency. The coincidence effect continues at higher frequencies but the loss of insulation is gradually reduced.

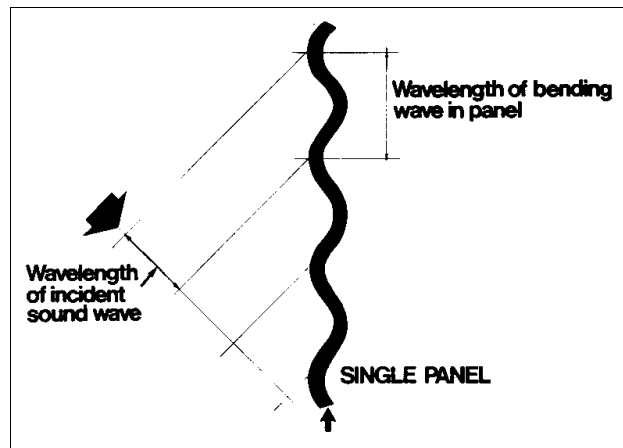

Fig 18 Coincidence Effect

With the insulation of typical partitions affected by resonances (panel vibration) at the lower frequencies and the Coincidence effect at the higher frequencies, ideal materials for partitions should give rise to resonances outside the normal building acoustic range and internally damped. For instance 18mm of sheet lead, a highly internally damped material, has a superficial mass of 200 kg/m² and a critical frequency of 15 000 Hz whereas 20mm of plasterboard has a superficial mass of only 18 kg/m² and a Critical Frequency of 2 000 Hz. Stiff materials show a reduced Coincidence Effect and improved insulation at the resonances if external damping is provided by the fixings. Lead clearly has many disadvantages, it can flow under its own weight, but it can be incorporated within the sheet material.

It is worth noting that for glass the Critical Frequency is given by:

$$f_{crit} = 12/h \text{ Hz where } h \text{ is the thickness in mm.}$$

Multiple Constructions

The practical increase in sound insulation of about 4 or 5dB per doubling of mass implies that massive constructions would be necessary to achieve high levels of insulation. For instance a typical 200mm concrete wall, superficial mass 400 kg/m², gives an insulation of about 50 dB. In order to achieve 60dB insulation an 800mm wall would be required! A similar problem arises with glazing. Single 4mm glazing may give 20dB insulation but to achieve 50dB it would need to be 200mm thick! If two layers of material are used separated from each other then the insulations can be added. Potentially two layers of 4 mm glass could give 40dB insulation. This assumes that there is no acoustical connection between the sheets of glazing but air is stiff and there will be some connection at the frame. Small air gaps are stiffer and therefore double glazing with small air gaps shows limited improvement in insulation. The major problem affecting any multiple construction is the mass-air-mass resonance as outlined in the section on absorption. This can reduce the insulation below that of a single panel. Above this frequency in the mass law region the insulation of a double partition theoretically increases by 12db per doubling of mass (or nearer 9 or 10dB in practice). The mass-air-mass resonance is inversely proportional to the square root of the air

gap. A typical narrow gap sealed double glazed window has a mass-air-mass resonant frequency at about 280 Hz where a typical secondary glazed or double window unit has a resonance at about 70 Hz (about 200mm gap). Field studies (ref 12) have shown the following noise reductions. While the large air gap system is nearly always recommended for sound insulation it can be seen that the real insulation achieved depends very much on the frequency spectrum of the noise. For noises with a large high frequency content such as aircraft noise the choice is clear. The large air gap should be used. For noises with a high low frequency content the decision is less clear. Double windows are more difficult to maintain and keep sealed. Practical results (ref 12) showed that measured against road traffic noise the insulation of a double window was less than 1 dB better on average than a double glazed unit. Most descriptors of sound insulation use the standard building acoustics range of 100Hz to 3150 Hz. The average sound insulation over this range shows the double windows 3.5dB better and the weighted standardised sound level difference (see later notes) shows the double windows 5dB better. With road traffic noise using this frequency range can be questionable.

For good sound insulation with glazing systems (e.g. for radio/sound studios) the following precautions should be taken:

- 1) Use as wide an air gap as possible.
- 2) Use different thicknesses of glass (gives different critical frequencies).
- 3) Glazing sheets should be out of parallel(reduces resonance effects).
- 4) The reveals should be lined with acoustic absorber (reduces standing waves)
- 5) Use good flexible seals.

Double walls need to be constructed with the same principles in mind. A typical brick cavity party wall with 50mm air gap has little better average insulation than a solid wall of the same mass. Increasing the air gap to 75 mm provides such an increase in insulation that the U.K. Building Regulations allow a reduction in total superficial mass of the party wall to 270 kg/m² from 400 kg/m² as likely to satisfy the requirements subject to workmanship.

The equivalent to the double partition is the floating floor. The separating material is resilient such as a mineral wool quilt which has very different impedance to that of the floor construction. The form may take that of a concrete floating floor with a screed on top of the quilt placed on the concrete floor or as a timber raft floor. Timber joist floors as found in many older European constructions can be improved by the addition of a floating layer or by using an independently supported additional ceiling below. This is now almost a universal requirement in the U.K. when larger older houses are converted into flats because of considerable noise complaints that have arisen.

Partitions with more than one element

Where a partition contains a more than one element e.g. glazing in a block wall the mean SRI can be calculated using the area weighted average of the transmission coefficients. As an example if we take a 10 m² concrete wall of SRI = 50dB (T = 10⁻⁵) containing 2 m² glazing of SRI = 20dB (T = 10⁻²) then the mean SRI is 27dB. Notice that a small area of poor insulation has a large effect. This is most noticeable with small air gaps e.g. cracks round windows. It is easy to show that the insulation

is substantially reduced. It is very important in acoustic detailing to ensure that all gaps are well sealed.

Flanking Transmission

The sound transmission between two rooms is determined not simply by the insulation of the intervening partition. Flanking paths must also be considered. These can be structure borne paths such as along flanking walls or by sound going out of a window and back in another in the adjacent room. The former is best analysed by statistical energy theory. A useful introduction is provided by Craik (ref 13). The practical insulation of a heavy partition wall will be considerably reduced by lightweight flanking walls. Discontinuities in the flanking walls (e.g. windows) near the junction with the partition help reduce the flanking transmission. The mode of fixing of the partition (or party wall) into the flanking walls is also of importance.

Sound Insulation Requirements

Sound Insulation requirements are divided into airborne and impact. The former measures the sound level difference between the sound level in room and that in an adjacent room. The impact sound level measures the sound level in a room when the floor above is directly excited by a standard tapping machine, measuring the insulation against noise created by such sources as footsteps.

Airborne Sound Insulation

In a laboratory a transmission suite of two adjacent parallel rooms described in BS 2750 or ISO 140 is used to measure airborne sound insulation and by correction for the absorption area in the receiving room and the partition area the sound reduction index can be calculated. For building acoustics measurements are made in the 16 1/3rd octave bands between 100Hz and 3150 Hz.

The sound reduction index (SRI), also known in the USA as the transmission loss, is then given by:

$$\text{SRI} = L_1 - L_2 + 10 \log S/A \text{ dB}$$

where L_1 = average sound pressure in the source room
 L_2 = average sound pressure in the receiving room
 S = area of the dividing partition
 A = absorption area of the receiving room

For field measurements the standardised sound level difference is given by

$D_{nt} = L_1 - L_2 + 10 \log (t/0.5)$ where t is the reverberation time of the receiving room. 0.5s is assumed to be the reverberation time of a typical sitting room.

In the U.K. BS5821 describes a method for achieving a single rating, either the weighted sound reduction index (R_w) (laboratory) or the weighted standardised sound level difference (D_{ntw}) (field). This compares the measured values with standard

curves the rating specified by the curve @500 Hz. To satisfy the rating the partition should not have a total aggregated deviation of more than 32dB and in no single 1/3rd fail by more than 8dB.

Impact insulation

Impact insulation is measured as the actual sound level experienced in a receiving room below a source room where the floor is excited by a standard tapping machine

In the laboratory the the normalised impact sound pressure level is calculated from:

$$L_m = L_i - 10 \log (A_0/A)$$

where L_i = measured impact sound level

A_0 is the reference absorption area

A is the absorption area of the receiving room

For field measurements the standardised impact sound pressure is calculated from:

$$L_{nt} = L_i + 10 \log (0.5/t)$$

where t is the reverberation time of the receiving room.

The weighted standardised impact sound pressure level is calculated according to a similar procedure to that of the airborne sound insulation.

Noise Control

In problems associated with noise it is always best to try and control the noise at source. This may be possible with machines but cannot be fully successful with sources such as traffic or aircraft, despite increasing attempts to make these quieter. In building design space planning can help avoid expensive solutions at a later date. Noise sensitive spaces should be placed away from noise sources. Airborne and structure borne noise need to be considered. Machines will usually transmit most of their low frequency sound energy directly into the floor so that good insulation over the whole frequency range cannot be achieved by a simple enclosure but the machine needs to be isolated from the floor. This is done using vibration isolators which are found in the form of a resilient pad (e.g. rubber) or as steel springs. The theory of vibration isolation is discussed in appendix 2.

Mechanical service noise can be a problem in buildings. This can arise from the boilers, compressors for cooling units, pumps and fans. Apart from normal airborne and structure borne transmission Noise can be transmitted through pipes but from the fans the noise will be duct borne. The main sources of fan noise are caused by boundary layer separation as air flows over the blades and the vortices created at the tips of the blades. Centrifugal, axial and propeller fans have different noise spectrums but all fans tend to be tonal related to the fan running speed and the number of blades on the fan. Out of balance fans can be particularly noisy and the noise from failed bearings often give warning of early failure.

Duct borne noise can be controlled by silencers. These can be reactive or absorptive. The attenuation achieved by a duct is normally described in terms of the Insertion Loss. This is the difference in decibels between the sound pressure levels, assuming the area of duct remains the same before and after insertion, or otherwise the sound

power levels, at a point in the ducting before and after the silencer is fitted. High frequency waves have short wavelengths which are smaller than normal duct dimensions. If there is a contraction within the duct, some sound will be reflected back up the duct and some transmitted. The transmission coefficient (T) is simply given by:

$T = S_2/S_1$ where S_1 is the original duct area and S_2 the changed duct area.

At enlargements all sound power is transmitted (although the sound pressure level will change)

Larger wavelengths need to be treated differently. A similar approach to that employed earlier in determining boundary transmission needs to be employed (velocity and pressure continuity).

This leads to a transmission coefficient = $4(S_1/S_2)/(1 + S_1/S_2)^2$ and an end reflection at low frequencies with sudden enlargements.

End reflection is a useful source of low frequency sound attenuation in ducts. Plenum and expansion chambers and multiple systems of expansion and contraction can provide good low/mid frequency absorption and are known as reactive systems. Mid/high frequency noise is better controlled by absorptive silencers. Ducts themselves bend and flex and absorb some sound. By lining the ducts internally with absorber the attenuation is given by:

Attenuation = $3.5 \alpha^{1.4} P/S$ dB per metre

where α is the absorption coefficient

P is the perimeter of the duct in metres

S is the cross-sectional area of the duct in square metres

To increase the area of absorber splitters are often used. To avoid regenerated noise, that is aerodynamic noise generated by the increased air flow, the cross-sectional area available within the silencer should not be less than that in the duct. Care must be taken with ducts to avoid noise breakout and breakin. Either the duct should be well insulated or the silencer placed at the partition junction where the duct moves from a noisy to quiet area. In critical situations the duct should be suspended by resilient hangers to avoid structure borne transmission.

References

1. L. Cremer and H. Muller (trans Schultz). Principles and Applications of Room Acoustics (Vol 1.) Applied Science 1982
2. Architectural Acoustics. Bruel and Kjaer 1978
3. Guide to Acoustic Practice (2nd Edition). British Broadcasting Corporation. 1990
4. H. Kuttruff. Room Acoustics (2nd Edition) Applied Science
5. M. Barron. *Subjective Survey of UK Concert Halls*. Proc IOA Vol 7 Part 1 1985 pp

43-46.

6. R. Hawkes and H. Douglas. *Subjective Acoustic Experience in Concert Auditoria* Acustica 24 1971 pp 235-250

7. N. Edwards (Artec Consultants inc.N.Y) *Design Methods in Auditorium Acoustics*, Proc IOA Vol 7 Part 1 1985 pp 73-79

8. L.Beranek. *How they Sound: Concert and Opera Halls*; To be published Acoustic Society of America 1996

9. E. Rathe. *Note on Two Common Problems of Sound Propagation*. Journal Sound and Vibration 10(3), pp 472-479 1969

10. G. Porges. *Applied Acoustics*. Edward Arnold 1977

11. Fry et al. *Noise Control in Building Services*. Pergammon Press 1988

12. W. Utley and J. Sargent. *Noise Reduction of Dwellings against Traffic Noise*. Proc.IOA. Vol 8 Part 4 1986 pp 143-150

13. R. Craik. *The Application of Statistical Energy Theory to Sound transmission through Buildings*. IP3, BEPAC Information Papers 1995 (BEPAC address: 16 Nursery Gardens, Purley on Thames, Reading, RG8 8AS, UK.)

Additional Useful Reading

Parkin, Humphries and Cowell. *Acoustics, Noise and Buildings* 4th ed. 1979, Faber ISBN 0- 571- 04953- 2

Sound Control for Homes BRE and CIRIA 1993 ISBN 0-85125-559-0

M. Wilson *A Review of Acoustic Problems in Passive Solar Design*, Proc IOA Vol 14 Part4 (1992) (Euronoise '92) ISBN 1- 873082 See Appendix 1

Appendix 1

A REVIEW OF ACOUSTIC PROBLEMS IN PASSIVE SOLAR DESIGN

.

INTRODUCTION

The future of the planet may well depend on us changing our attitudes to the design of buildings. We can no longer afford the building equivalent of the 'gas guzzler'. Passive Solar Design uses renewable energy to limit fossil fuel consumption.

This paper examines the impact of such design decisions on the acoustic environment.

PASSIVE SOLAR DESIGN

With approximately 50% of the annual primary energy consumption within the UK being used by buildings it is not surprising that growing concern about the greenhouse effect has given an impetus to energy efficient design. Commercial buildings account for about 30% of this building energy consumption. While a decade ago the emphasis on reducing energy was focused on domestic buildings, commercial buildings have recently been attracting more attention. The principles of passive solar design can be applied to both domestic and commercial buildings though the potential energy savings come in different forms.

In housing, after adequately insulating, siting, differential sizing of windows according to orientation, high performance glazing and the use of pre-heat ventilation from sun spaces (conservatories) have been used in passive solar design.⁷ For commercial buildings it appears that the greatest savings will come from daylight substitution for electric lighting and the use of natural ventilation. Atria have the potential to contribute to energy savings but often do the opposite.

The problems of natural ventilation and summer overheating, especially in offices, are those that are most likely to lead to acoustic problems.

Passive solar housing schemes have so far generally been developed on green-field sites without much traffic noise problem and large natural ventilation rates can consequently be achieved by simply opening windows. If some sound attenuation is required moderate ventilation rates (2-5a.c.h.) may be achieved by staggered opening of secondary glazing systems and others described later. An angled transparent sound reflector at present under development may allow even higher ventilation rates. While dwellings can overheat, often these can be solved by the much greater control and freedom of movement that exists for the individual in such spaces as opposed to non-domestic buildings.

CRITERIA

In commercial buildings the situation becomes far more complicated. Comfort conditions, thermal, acoustic and lighting, are fairly rigidly laid down for an office. A naturally ventilated space is unlikely to satisfy these criteria all the time. Overheating may occur on some days, noise levels may be high and lighting may be more variable. It is going to be necessary to establish what variability is allowable. There is strong evidence to suggest that people feel better in naturally ventilated buildings. In an early study of building sickness syndrome¹ comparing workers in almost identical air-conditioned and naturally ventilated offices identifiable medical symptoms were much more common in the air-conditioned offices.

Later in a similar study it was reported² that an important contributing factor to building sickness was the reduced level of control that individuals have over the environmental conditions when buildings are sealed which heightens the perceptions of discomfort. Griffiths³ found that the greater variability in temperature in passive solar buildings did not appear to affect thermal comfort and that people did not find such changes unpleasant.

The acoustic environment is one contribution to the total environmental comfort in a space.

Its relative importance in relation to thermal and visual comfort will depend on the nature of the space. The acoustic criteria for offices are laid down for the modern air-conditioning office, with the air conditioning playing an important role in acoustic privacy and the sealed glazing keeping out noise. These are $L_{Aeq}=40-45dB$ or $L_{Aeq}45-50dB^5$ (NR35 or NR40⁴) depending on the type of office and are as much minimum as maximum. While road traffic noise may be intrusive it has already been suggested that people will tolerate higher levels of low frequency sound so that laminated glass can be used in fast track construction. To what extent these levels can be increased to allow natural ventilation where intrusive road traffic noise exists is a matter for the total comfort sensation of the office as a whole. But are there limits?

Maximum intrusive noise levels to allow normal speech conversation are $L_{Aeq}=51dB$ at 2m and $L_{Aeq}=57dB$ at 1m.⁵ Telephone conversations are satisfactory at 58dBA or NR50, slightly difficult at 68dBA or NR60.⁴ Perhaps an absolute maximum could be set at $L_{Aeq}55-60dB$? These may describe the upper limits for noise within the office but there is still a need for a minimum. Sound masking systems fulfill this function adequately at the moment but it is sometimes difficult to persuade a client demanding a 'green' 'healthy' building that electronically created noise is necessary.

SOUND ABSORPTION AND THERMAL MASS

Without air-conditioning the passive solar building loses the need for a ceiling void behind acoustic tiles with the minimal services supplied in a small raised floor. Acoustic control is still needed but application of acoustic treatments in the form of a suspended ceiling or by direct attachment to the ceiling creates thermal insulation between the air and the ceiling. mass is an important element in the design of naturally ventilated buildings as it helps to prevent overheating. Access to the floor slab is prevented with a raised floor and/or carpets so the ceiling needs to be exposed.

It has been reported⁶ that an exposed ceiling will reduce the room temperature on a warm day by 1-2°C or that the internal heat load can be increased by 5-10W/m². This can be maintained over a long period by night-time ventilation.

The effect is almost maintained if a suspended ceiling is in place with 11% of the tiles removed in strips. The consequences on reverberation time of the room is marginal but there will be increased problems of room to room transmission. Physical barriers above partitions may be the only solution as acoustic treatment of the underside of the floor slab will act against providing thermal mass. These barriers are not easy to implement if the void carries services^{7,8}.

The role of the convection currents set up in the void is obviously very important and a similar thermal performance could not be expected from the use of directly attached tiles or from a shallow void designed to satisfy the lighting requirements. No data is available although suggestions are being made (though not in print!) that for directly attached tiles about 80% of the ceiling area needs to be exposed. There must be doubts about this area of tiles being acoustically satisfactory. At the moment a voidless ceiling is only likely to be aesthetically compatible with an uplighting system. These systems use high pressure sodium and metal halide discharge lamps which are not yet compatible with daylight substitution electric light controls and therefore not suited to daylight buildings.

open grid ceilings will fulfill the requirement for access to thermal mass but the incorporation of the acoustic absorber needs careful consideration. Vertical acoustic elements (akin to the

functional absorbers used in factories and sports halls) may be fixed above the open grid but in such a manner that convection currents are encouraged to expose the thermal mass to the mixed room air.

It is worth noting that the elimination or reduction of the void can have positive energy benefits by increasing window height or immediate economic benefits during construction by reduction of floor to floor heights.

NATURAL VENTILATION SYSTEMS

It was argued earlier that acoustic criteria will have to be interpreted with more flexibility and that insulating against road traffic noise and in some cases aircraft noise is likely to cause most problems for naturally ventilated buildings. High ventilation rates required to avoid summer overheating in commercial buildings are not compatible with good sound insulation. However it has been mentioned that certain systems can give some sound insulation in conjunction with moderate air change rates (2-5a.c.h.). Secondary glazed systems allowing a staggered 100 mm open gap on each pane have been shown to give a sound insulation of 27dBA-30dBA depending on the type of noise.^{9,10}

Recent work at the BRE¹¹ has looked at trickle ventilators and passive stack ventilators applicable to domestic buildings. Trickle ventilators are holes or slots. Holes generally provide better attenuation than equivalent slots and the actual transmission naturally depended on size. In general those tested provided no worse attenuation than closed single glazing below 630 Hz and below 315 Hz with secondary glazing. At the higher frequencies the performance was no worse than opening the windows. Passive stack ventilators performed similarly though better attenuation would be provided against traffic noise than aircraft noise because of the change in angle of incidence of the noise. The type of duct was important in the performance above 630 Hz. Rather interestingly a larger 155mm duct gave better attenuation than a 100mm duct. The nature of the termination and type of duct affected both the acoustic performance and ventilation rate generally in opposite directions. Attenuators may be necessary but they can become very large in commercial buildings. Solar chimneys have similar problems as they are designed to move the air quicker, thereby helping reduce overheating.

Essentially a part glazed vertical duct exposed to the sun, the air is warmed and the stack effect increased. They are not common in the UK but a study centre for the Centre for Alternative Technology, Machynlleth, Wales¹², proposes to use them to provide summer time ventilation for bedrooms located behind a glazed buffer space. Duct areas are large but in this case the problem is potentially cross-talk and can easily be solved by designing a separate chimney for each bedroom. In other cases where a chimney, solar wall or double skin type system may have to serve several vertically arranged spaces the solution is not so simple.

While the stack-ventilator or solar chimney itself may cause problems the air inlet needs to be considered. The proposed Energy faculty Building at Leicester Polytechnic¹³ uses passive stack ventilation chimneys to ventilate a lecture theatre, the air being drawn through grilles under the seats from the outside via the plenum created by the builders work. The problem is obtaining sufficient sound attenuation with minimal flow resistance. Traffic noise is around 70 dBA in the street outside and very large attenuators have been provided. In addition the chimneys have been lined with acoustic absorber

ATRIA

Another concern in passive solar design is atria. Atria have the potential for improving the energy efficiency of a building if unheated or minimally heated. Mostly designed with hard finishes the reverberation times are often high and sometimes boasted about. The problems arising will depend on use of the surrounding spaces, the use of the atria and the size of the atria. Despite a long reverberation time the reverberant sound level in large spaces is low and it is likely to be the smaller atria where problems could arise. In some cases the acoustics of small atria such as the Cambridge Consultants building in Cambridge Science Park have benefited from acoustic treatment of the surface.

In a recent International Energy Agency Task Group XI report on Passive Solar and Hybrid Commercial Buildings,¹⁴ three social surveys give an insight into the occupants' reaction to noise in atria. These were either retrofit atria or extensions to existing buildings and in two cases before and after studies could be done. The first dealt with was that of the Tegut Company, Fulda, Germany. Additional office space was created and then glazed over. The glazed area was heavily planted. With office workers moving from the air-conditioned spaces to the atrium pavilions there was a slight reduction in the perceived noisiness although they remained on the noisy side of neutral. The air-conditioning in the original offices had been causing noise problems.

In another development at the Norwegian Institute of Technology, the extension to the Department of Electrical Engineering and Computer Science, several new office and laboratory buildings were linked to each other and existing buildings by glazed spaces. The occupants found the building slightly noisy but a concluding remark was 'noise levels in the atria and noise disturbance from the atria to office spaces also gave rise to some complaints.' This apparently arose because groups of students congregate in the atria to drink coffee and make conversation.

Finally a development in Wasa City, Gaule, Sweden, involved glazing over an area linking dwellings, shops and offices. The social survey was designed for the residents, many of whom had lived in the dwellings before retrofit. Traffic noise in the area was very high but the report comments: 'Rooms badly affected by noise lie to the same extent facing the courtyard as facing the street. During the summer the ventilation shutters in the roof cause noise. In winter, snow on the roof makes noise as it slides down the glass in great chunks. Also the wooden duckboards in the open spaces in the atrium were mentioned as a source of noise. Noise is intensified in the atrium'.

While it would be unwise to draw any general conclusion from the surveys, they do tend to confirm current opinion. Noise problems created in offices by atria are less likely in large than small atria. Problems can arise if activities occur in the atria which create noise, Eg the congregation of a fairly large number of students at a coffee bar in the atrium or if a small orchestra or band is employed to play. The type of space surrounding the atrium is important. Dwellings and possibly teaching spaces are likely to be much more sensitive than offices.

REFERENCES

1. Comparison of health problems related to work and environmental measurements in office buildings with different ventilation systems, Robertson et Al, British Medical Journal, 291,

pp373-376,. 1985

2. Sick Building Syndrome and Environmental Conditions: Case studies of nine buildings, Sheena Wilson, Pat O'Sullivan, Alan Hedge, Philip Jones, Building Use Studies Ltd., 1987

3. Field studies of thermal comfort in passive solar buildings, ID Griffiths, Second European Conference on Science and Technology at the Service of Architecture, Paris 1990, pp 99-102

4. CIBSE Guide A, 1986

5. BS 8233: 1987

6. Making use of the, thermal mass of the building using thermally open ceilings, H M Bruggema, Energy, Moisture and Climate in Buildings Symposium, September 1990, Rotterdam.

7. Acoustic Privacy in offices - Real and Imagined, PH Alloway, Proc IOA, Volume 8, Part 1 (1986), pp 39-44.

8. Acoustic Privacy between offices, PH Alloway, Proc IOA, (1989), pp 45-49.

9. The field performance of partially open dual glazing, G Kerry and R D Ford, Applied Acoustics (7), 1974, pp 213-227.

10. BRE Information Paper 12/89, The insulation of dwellings against external noise.

11. The sound attenuation of passive ventilators, S Jarro, Proc IOA, 1990, 12 (5) pp 41-47

12. Solar architecture as an initiator for unconventional planning and daylighting techniques, Y Dean, M Wilson, J Walker, Second European Conference on Science and Technology at the Service of Architecture, Paris 1989 pp24-26

13. Design of a naturally ventilated laboratory building in Leicester, England, B Ford and A Short, PLEA 191, Seville 1991, pp 319-324

14. Passive and Hybrid Solar Commercial Buildings, IEA Task Group XI, Advanced Case Studies Seminar, April 1991

Appendix 2

THE NATURE OF VIBRATION : BASIC CONCEPTS AND DESCRIPTORS

Introduction

This Section begins with a consideration of the nature of vibration, and of the terms and

parameters which may be used to describe and measure it, starting with the simplest, single frequency vibration and then continuing to more complex types.

Single frequency vibration

A vibration is a type of motion in which there is a to and fro oscillation about a fixed position. In the case of the simplest type of vibration the **displacement**, from the fixed position varies sinusoidally with time, t , and described mathematically by :

$$x = X.\sin t = X \sin 2ft$$

where X is the vibration amplitude, and ω is the angular frequency, in radians per second, equal to $2f$, where f is the **frequency** of the vibration, in cycles per second, or **Hertz**. Frequency is the reciprocal of the **period**, T , of the vibration, which is the time taken for one complete cycle of the motion to occur.

$$\text{ie } f = 1/T$$

The Root Mean Square value, RMS, of a vibration is given by :

where $x(t)$ denotes that displacement x is a function of time, t .

In the case of a sine wave vibration where $x = X\sin 2ft$, evaluation of the above expression shows that $\text{RMS} = X/\sqrt{2}$ ie that:

$$\text{RMS} = \text{PEAK} / \sqrt{2} = 0.7071 \times \text{PEAK}$$

In this case also, the **peak** value is the same as the **amplitude**, and the **peak to peak** value is twice the amplitude. A reduction by a factor of $\sqrt{2}$ in terms of displacement corresponds to a reduction by a factor of 2 in vibration energy (compare with the relationship: sound intensity (sound pressure)²) so that, for a sinusoidal vibration the RMS value is 3 dB below the peak value.

Displacement, Velocity and Acceleration

Velocity is the rate of change of displacement, with respect to changes in time. During a complete cycle of the vibration the velocity also changes, through a complete cycle, as well as the displacement. Similarly acceleration is rate of change of velocity, and cyclic changes of acceleration will also occur during the vibration. These three cycles have the same frequency, but different amplitudes: X (displacement), V (velocity), and A (Acceleration).

Displacement, velocity and acceleration therefore give three different ways in which a vibration may be described and measured. The three are obviously related, and, for single frequency vibration, sinusoidal vibration only the relationships, between the three amplitudes are:

$$V = 2fX$$

$$\text{and } A = 2fV$$

from which $A = 4f^2 X$

A similar set of equations relate the three RMS values.

Displacement, X may be measured in m., mm. or μ . (microns). Velocity, V , may be measured in $m.s^{-1}$, or $mm.s^{-1}$. Acceleration, A , is measured in $m.s^{-2}$.

Vibration Isolation

A vibration isolator is a spring or mount which reduces the transmission of the vibration to the structure at frequencies $2^{1/2}$ x natural frequency of spring or mount. The transmissibility (T) is given by

$$T = 1 / (1 - [f/f_r]^2)$$

where f is the driving frequency
and f_r is the natural frequency of mount (isolator)

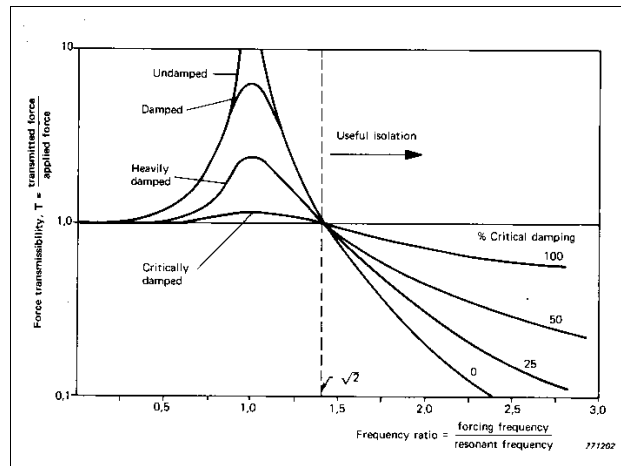

Springs and mounts may be simply sized by their static deflection under load. The natural frequency of the loaded mount is given by:

$f_r = 15.8/d^{1/2}$ where d is the static deflection in mm and f_r the natural frequency of the loaded mount.

More Complex Vibrations, and Vibration Spectra. More complex vibrations may be thought of as being built from a combination of simple sinusoidal vibrations, and represented by a frequency spectrum. The frequency spectrum of a single frequency vibration with a sinusoidal waveform is a single line. Vibrations with a **harmonic** waveform, ie one which repeats itself exactly, have a line spectrum, in which the frequency components are integer multiples of the fundamental frequency defined by the period of the waveform. Such a series of lines is often called a Fourier series, after the French mathematician J.B.Fourier (1768-1830) who showed that any repetitive function can be broken down (ie analysed into) a series of sinusoidal functions. The waveform of a **random** vibration never repeats itself and has a continuous

frequency spectrum, ie one in which the lines have moved infinitesimally close together. This continuous spectrum may be analysed into octave or one-third octave bands, exactly as for sound signals. The spectrum of a single **transient** vibration is also a continuous spectrum, with, usually, higher levels at the lower frequencies and with the levels reducing at higher frequencies. **Repeated transients** produce a line spectrum in which the line spacing is determined by the repetition rate, but where the shape of the spectrum is determined by the waveform of the transient. Examples include the vibration produced by rotating machines such as fans, pumps and motors, and reciprocating machines such as engines.

THE EFFECTS OF VIBRATION ON PEOPLE

Depending upon the level, and a variety of other factors, vibration may affect people's comfort and well-being, impair their efficiency at performing a variety of tasks. or even at very high levels become a hazard to their health and safety. The best known example of the harmful effects of vibration is the White Finger syndrome (also known as Reynaud's disease) in which prolonged use of hand-held equipment, such as chain saws, in very cold conditions. produces loss of sensation in the fingers. The vibration produced by the various forms of transportation (e.g. road traffic, trains and aircraft) is of great interest for a variety of reasons. First of all. there is concern about the safety and efficiency of the driver or operator subjected to vibration; secondly, there is the effect of vibration levels on the comfort of passengers; and thirdly, there is often great concern amongst members of the public about vibration produced in buildings. including domestic dwellings adjacent to roads or railway lines or near to air routes. A great variety of industrial machinery produces vibration which is experienced by people at work. Particular sources which can cause vibration to be experienced by the occupants of nearby buildings and thus often give rise to concern amongst members of the public include heavy-duty air compressors, forge hammers, pile driving and quarry blasting operations.

FACTORS INVOLVED IN HUMAN RESPONSE TO VIBRATION

The assessment of human response to vibration is made difficult by the fact that there are a large number of factors involved, and because of the great differences between individuals. The main physical factors determining the response to a vibration are the amplitude (or intensity) and frequency, and also the duration (exposure time), point of application and direction of the vibration. Amongst the configurations which are of interest are the transmission of vibration from the floor through the feet of the standing person and from the seat via the buttocks and possibly the head (through the headrest) of the seated person. In these cases the vibration may be transmitted and felt throughout all parts of the body, and it is the whole body response which will be required. In other cases the vibration may be applied and sensed at a particular part of the body - the vibration produced in the fingers and hands by power tools being a good example. In this particular case it is the response of the hand-arm system which is important.

As far as vibration transmission is concerned. the human body may be thought of as a complex mass-spring system. It therefore has a complicated frequency response which includes resonances associated with either the whole body or various parts of the body such as the head or the shoulder girdle. These frequencies may vary greatly for different people. Different parts of the body are therefore most sensitive to different frequencies of vibration. Therefore there is not only a difference in individual sensitivity to vibration, but also a

difference in individual transmissibility as well. Even the response of any one individual can vary with posture and body tension. The situation may be further complicated by the effects of seats, headrest, gloves, etc., unless great care is taken to measure the vibration level at the exact point of application of the vibration to the body. One more difficulty in the assessment of human response to vibration is in separating it from the response to the high noise levels which are often associated with vibration-causing processes.

EARLY RESEARCH INTO HUMAN RESPONSE : THE REIHER-MEISTER AND THE DIECKMANN SCALES FOR VIBRATION ASSESSMENT

Many schemes have been developed for the assessment of human response to vibration. One of the earliest, published by Reiher and Meister in 1931, covers the frequency range 1-100 Hz and vibration amplitudes, specified as displacements in the range 1-100 μ m. Using the Reiher-Meister scale it is possible to rate the vibration as belonging to one of six categories ranging from imperceptible to painful. Separate scales are used for vibrations in the vertical and horizontal directions. The threshold of perception corresponds to a velocity amplitude of 0.3 mm/s and the annoyance threshold to 2.5 mm/s.

Dieckmann, in 1955, proposed a similar scheme but extending to lower frequencies (down to 0.1 Hz) and higher amplitudes than Reiher and Meister. The vibration level is quantified in terms of K-values, ranging from 0.1 to 100, which are related to the intensity. The effect of a vibration can be assessed from its K-value:

- K = 0.1 - lower limit of perception
- K = 1 - allowable in industry for any period of time
- K = 10 - allowable only for a short time
- K = 100 - upper limit of strain allowable for the average man

The K-values may be read off charts of frequency against amplitude, similar to the Reiher-Meister scales, or they may be calculated in terms of displacement amplitude A and frequency f.

BRITISH AND INTERNATIONAL STANDARDS ON HUMAN RESPONSE TO VIBRATION

ISO 2631 Evaluation of human exposure to whole-body vibration

The Introduction to the standard states that : "Various methods rating the severity of exposure and defining limits of exposure based on laboratory or field data have been developed in the past for specific applications. None of these methods can be considered applicable in all situations and consequently none has been universally accepted.

In view of the complex factors determining the human response vibrations, and in view of the shortage of consistent quantitative data concerning man's perception of vibration and his reactions to it, this International Standard has been prepared first, to facilitate the evaluation and comparison of data gained from continuing research in the field; and, second, to give provisional guidance as to acceptable human exposure to whole body vibration."

Part 1 1985 : General requirements

This Part of the standard takes into account frequency (in the range 1-80 Hz), vibration amplitude (acceleration), duration (from 1 minute to 24 hours exposure) and the direction of the vibration relative to the human body. Three different criteria are proposed; working efficiency, health and safety, and comfort. These three criteria give rise to three boundaries or limits; the fatigued decreased proficiency boundary, the exposure limit (for health and safety), and the reduced comfort boundary. Fig. shows the limits for the fatigued decreased proficiency boundary in terms of the amplitude, frequency and duration for a vertical vibration (along the toe-to-head axis). Exposure limits are 6 dB above and reduced comfort values 10 dB below these values, the shape of the contours remaining the same. The human subject is most sensitive to vertical vibrations in the frequency range 4-8 Hz. Above 8 Hz the response contours correspond to constant velocity amplitudes. The ISO standard also allows the effect of broad-band vibrations (i.e. containing many frequencies) to be evaluated .

Parts 2,3 and 4 of ISO 2631 are concerned with the vibration of humans in buildings, at low frequencies, and on board ships.

Part 2 1989 : Human exposure to continuous and shock-induced vibration in buildings (1 to 80 Hz).

Part 3 1985 : Evaluation of exposure to whole-body z-axis vertical vibration in the frequency range 0.1 to 0.63 Hz.

Part 4 : Evaluation of crew exposure to vibration on board sea-going ships (1 to 80 Hz). This part of the standard is at present at the stage of draft.

The subject matter of parts 1,2 and 3 of ISO 2631 are also cover by BS6841 and BS6472. Although there are some similarities there are also some very significant differences between the British and International Standards. One of these is the introduction of the concept of Vibration Dose Value into the British Standards, in order to take into account the effects of impulsive and intermittent vibration.

THE EFFECT OF VIBRATION ON BUILDINGS

It is almost inevitable that high noise and vibration levels experienced by the occupants of a building should give rise to concern about the possible effects that these may have on the building. However, cases in which even minor damage to a building can be attributed directly to the effects of vibration alone are very rare. Usually many other factors are involved as well, such as ground settlement or movement caused by changes of moisture content. It is generally accepted that the vibration levels in a building would become absolutely intolerable to the human occupants long before they reached a level at which there was danger of damage to the building. In cases where minor damage does occur, and in which vibration is alleged to play a part, the most common occurrences are: damage to unsound plaster, cracking of glass, loosening of roof tiles and cracks to masonry. However, it is very likely that existing minor damage may be noticed for the first time by an occupant whose attention and concern has been aroused by the disturbance caused by a new source of vibration.

Heavy vibrating machinery located at high levels in a building can produce intense vibrations in the horizontal direction, and these are more likely to be damaging than vertical vibration.

Bells situated in church towers can also produce high levels in the building structure. Sustained sources of vibration may produce resonances in buildings or parts of buildings. However, this is less likely to cause problems if the vibrations are transient. The natural frequency of a building will depend mainly on its height and base dimensions, typical values ranging from 10 Hz for a low building to 0.1 Hz for a very tall building. The natural frequency is of interest since this type of vibration may be excited by wind loading of the building. Floors, ceilings and windows also have their own natural frequencies. Typical values for floors are in the range 10-30 Hz depending on size and type of construction. People in buildings are more aware of vibrations transmitted via the floor than from any other part of the structure. It is important therefore that the natural frequency of the floor does not coincide with the range of maximum sensitivity (4-8 Hz) for vertical vibrations of the human body at which whole-body resonance occurs. The maximum amplitude usually occurs in the centre of the floor. Modern long-span floors are likely to cause an increase in floor vibration amplitudes. Natural frequencies of windows range from 10 to 100 Hz depending on the size and thickness of the glass, and for plaster ceilings typical values range from 10 to 20 Hz.

Many investigations have been carried out in an attempt to define threshold limits for the occurrence of vibration induced damage to buildings. The evidence from these investigation has been fully reported and discussed in a Building Research Establishment Report by R. Steffens entitled 'Structural Vibration and Damage', first published in 1974, and recently re-issued. In one investigation on the effects of blasting on buildings it was shown that buildings can withstand peak amplitudes of about 400 m. In contrast, typical levels produced in buildings by nearby road traffic often lie in the range 5-25 m. (10-30 Hz). It is often found that internal sources of vibration in a building, such as footsteps, door slamming, furniture moving, washing machines and vacuum cleaners, will produce levels comparable with or even greater than the external source which is the subject of complaint (road traffic, compressor, pile driver, etc.) Typical vibration levels produced by footsteps and by door slamming can be in the region of 50-150 m.

Other investigations have suggested that limits for damage are best expressed in terms of peak vibration velocity, and various values have been suggested ranging from 50 to 230 mm.s⁻¹ depending on the type of building and the degree of damage. For comparison it is interesting to note that a level of 75 mm.s⁻¹ corresponds to a Dieckmann K-value of 60, which would be extremely unpleasant, and is well into the painful zone of the Reiher-Meister scale (assuming frequencies in the range 5-40 Hz)

Yet another method for rating vibration, based on energy considerations and developed by Zeller in Germany, has been used for assessing possible damage to buildings. This involves the acceleration and the frequency of the vibration, the Zeller power being given by the acceleration squared divided by the frequency, and measured in mm²/Hz³.

BS7385 Evaluation and Measurement for Vibration in Buildings Part 1. Guide for measurement of vibrations and evaluation of their effects on buildings

This standard, which is identical to ISO 4866 :1990, discusses some of the principles involved in the measurement and evaluation of building vibration, and gives guidance on information to be recorded. The following factors are considered :

-the characteristics of vibration (type of signal, range of magnitudes and frequencies)

produced by different types of source, such as traffic, blasting, pile driving, and machinery

-type of building. Buildings are grouped into fourteen different classes, taking into account the different types of construction, types soil and foundations, and a political importance factor.

-selection of measurement parameters, equipment, transducers, measurement positions, data collection and analysis.

Most ground-borne vibration entering buildings from man-made sources is in the frequency range from 1Hz to 150 Hz. Natural sources such wind, and earthquakes produce significant amounts of vibrational energy lower frequencies, down to 0.1Hz. Vibration induced damage to buildings is classified into categories : cosmetic, minor and major.

Part 2 : 1993 Guide to damage levels from ground-borne vibration

The preferred method of measurement is to simultaneously record unfiltered time-histories of the three different orthogonal components (eg x, y, and z) of particle velocity. The (total) particle velocity may then be found, by taking the root mean square value of the three components, and its peak value obtained. The peak values of the individual components should also be measured, since it is this type of data which has usually been presented in the various case histories used to develop the limits in the standard.

The case history data suggests that the probability of damage tends towards zero at levels below 12.5 mm.s^{-1} peak component particle velocity. The limit for cosmetic damage varies from 15 mm.s^{-1} at 4 Hz to 50 mm.s^{-1} at 40Hz and above, for measurements taken at the base of the building. Different low frequency limits (below 40 Hz) are given for two different types of buildings. The limits for cosmetic damage should be doubled for minor damage, and doubled again for major damage.

BRE Digest 353, 1990 Damage to structures from ground-borne vibration

This Digest reviews various methods for measuring and assessing building damage caused by vibration, including German, Swiss and Swedish standards. The German standard, DIN 4150 Part 3 1986, which has been widely used, adopts a similar approach to B57385 Part 2. Guideline values of peak component particle velocity, in mm.s^{-1} , are given for three different types of building structure. Different limits are given for the frequency ranges : less than 10 Hz, 10 to 50 Hz, and 50 to 100 Hz.

SOURCES OF VIBRATION IN BUILDINGS

Road Traffic.

It is the variability of the interaction between tyres and the road which is the main source of vibration produced by traffic. 'Out of balance' forces produced by the operation of the vehicle also cause vibration, but with modern vehicles these are of less importance than the effects of variability in the road surface caused either by random surface roughness or by

imperfections such as bumps or potholes. A perfectly balanced engine driving a vehicle along a perfectly smooth road would not produce any vibration.

The main parameters determining the magnitude and frequency of traffic vibration are : road surface profile, vehicle mass and road speed, and the characteristics of the vehicle suspension system, and in particular its natural frequency.

Vibration from trains.

The vibration producing mechanisms are not fully understood, but it is believed that the main source of ground vibration from trains is the variability in the interaction between wheels and rails, arising from imperfections, irregularities and roughnesses in the surfaces of both. Irregularities in the track system supporting the rails may also cause vibration. The important parameters are rail and wheel profiles, vehicle mass, speed and suspension characteristics.

Wind induced vibration

Variability in the wind loading forces on buildings cause vibration, and this is particularly important for tall buildings. Steffens states that serious vibration in tall buildings is likely if the natural frequency of the building is less than the frequency of vortex shedding at the maximum wind velocity, and gives a method for calculating both quantities.

Other sources

Other sources of vibration in buildings include earthquakes, blasting operations, pile-driving, acoustic excitation eg from blasting, road and rail traffic and aircraft, machinery of various kinds, and human activities such as walking and door slamming. BS7385 Part 1 indicates the characteristics of vibration produced in buildings by various sources.

Steffens gives a fascinating and comprehensive account of vibration produced by a wide range of sources, including bell ringing, church organs, industrial knitting machines and door slamming, as well as all the sources mentioned above.

Vibration from pile-driving

There are many different methods of pile-driving, and these may result in vibration which is either continuous, or intermittent, or impulsive in nature.

BS5228 Part 4 (Appendix A) gives a detailed account of the characteristics of vibration associated with various types of pile-driving operations and a wide range of case study data.

Vibration from machinery

The motion associated with the operation of reciprocating machines (eg internal combustion engines) inevitably causes vibration. Rotating machinery (such as pumps, motors, fans) also causes vibration because there will always be some 'out of balance' forces associated with the rotary motion, although in principle the perfectly balanced rotating machine would not produce any vibration.

Vibration is also produced as a by-product of the 'working forces' associated with various types of machine including, for example: cutting, pressing, pumping, abrading and polishing, electrical forces in rotating machinery, combustion forces, aerodynamic and hydrodynamic forces in fans and pumps, forces in bearings, gear meshing forces, and impact forces.

Vibration is also produced by the imperfect operation of machinery caused by wear, looseness and mis-alignment of parts, and imperfect balancing. It is for this reason that good maintenance procedures are so important in minimising vibration and noise from machines.

Since most machinery operates on a cyclic basis of either rotational or reciprocal movement the frequency spectrum of machine vibration usually consists of a series of pure tone components (fundamentals and harmonics) associated with the repetition rates of the various cycles, (and with frequencies therefore dependent on machine speed), superimposed upon a broad band spectrum of raNDOM VIBRATION caused by impacts, wear, and irregularities in the machine motion. The narrow band component of the spectrum, or 'vibration signature' as it is sometimes known, can be used to diagnose the source of a particular noise or vibration frequency, eg to identify a particular set of gears, or fan or bearing. For a particular machine the spectrum can also be used to identify the vibration producing mechanism, such as 'out of balance' or 'misalignment' and this knowledge forms the basis of vibration monitoring of machinery in order to give early warning of malfunction.

THE TRANSMISSION OF VIBRATION

THE PROPAGATION OF VIBRATION IN UNIFORM MEDIA

There are two sorts of elastic waves which can travel in an infinite, ie unbounded homogeneous solid elastic medium: longitudinal compressional waves, often called P waves, and transverse shear waves, often called S waves. Only the P waves can be propagated in a fluid such as air or water. In bounded solids, such as plates, beams, rods and bars (such as in the elements of a building) there are in addition a number of other types of waves, such as flexural and torsional waves, which are combinations of the two main types. Also in bounded solids and fluids surface waves are transmitted, but, as the name suggests, only on and at limited depths below the surface. Surface waves in solids are also known as Rayleigh waves.

NB Homogeneous means having the same properties throughout the medium, ie 'being the same everywhere'. Isotropic means having the same properties in every direction

Propagation of ground-borne Vibration

Ground-borne vibration is, then, transmitted by P, S, and, near the surface, by Rayleigh waves. The velocity of shear waves in soils ranges from approximately, 30 m.s^{-1} to 300 m.s^{-1} , and for rock it is about 1000 m.s^{-1} . The velocities of compressional waves is about 2.5 to 4 times higher than for the shear waves, and the Rayleigh waves travel at speeds slightly lower than shear waves. The amplitude of surface waves reduces rapidly with depth below the surface, so that they are confined within a wavelength or so of the ground. Because of this Rayleigh waves are subject to less spreading loss than P or S waves, and especially in lightly damped soils or rock, they can travel greater distances with less attenuation.

The propagation of vibration in the idealised situation of an infinite, homogeneous, isotropic medium is well understood, and can be predicted from theory. The propagation of vibration in the ground is much more complex. Soils are not homogeneous, but are granular, with the voids between grains sometimes being filled with water. The medium is also usually non-isotropic, consisting of a number of strata or layers, each with different elastic properties. Additional types of waves arise from interactions at the boundaries between layers, and between waves propagating in the solid soil grains and the water surrounding them. There is usually inadequate or incomplete information about the thicknesses and extent of the various layers, and about the relevant elastic properties of each soil or rock type ie elastic moduli, density, wave speeds and damping constant.

I would like to thank Dr Bob Peters for the section on vibration